

Serie FLAT

Technische Informationen
 Technical information
 Informazioni tecniche

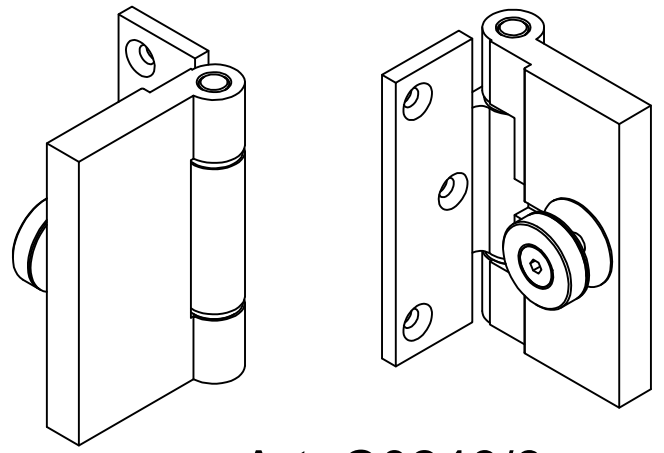

Art. C0246/6

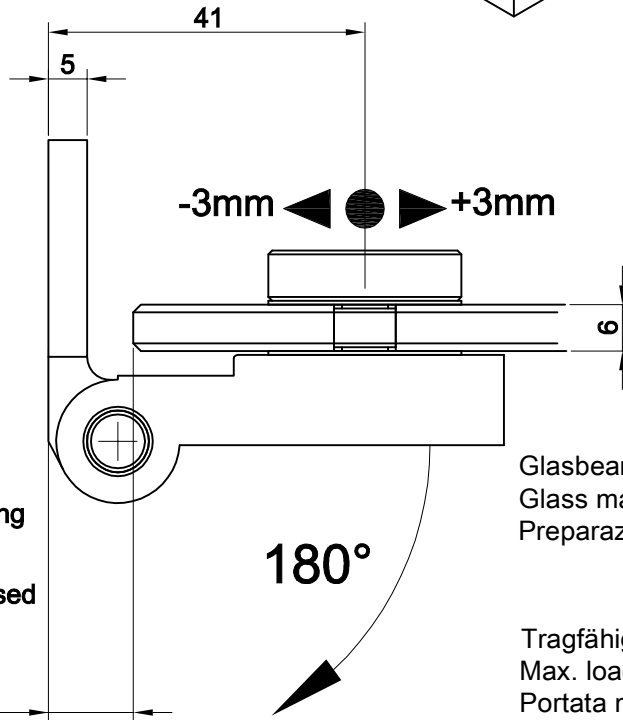

Spalt für die verwendete Dichtung zu berechnen

Calculate the gap for the seal used

Calcolare la distanza per la guarnizione utilizzata

Glasbearbeitung für
 Glass machining for
 Preparazione lastre

6mm

Tragfähigkeit, 2 Bänder
 Max. loading weight, 2 hinges
 Portata massima, 2 cerniere

40Kg

Maximale Türbreite
 Max. Door width
 Larghezza max. porta

900x2000mm

